

**GENUINE ACCESSORIES**

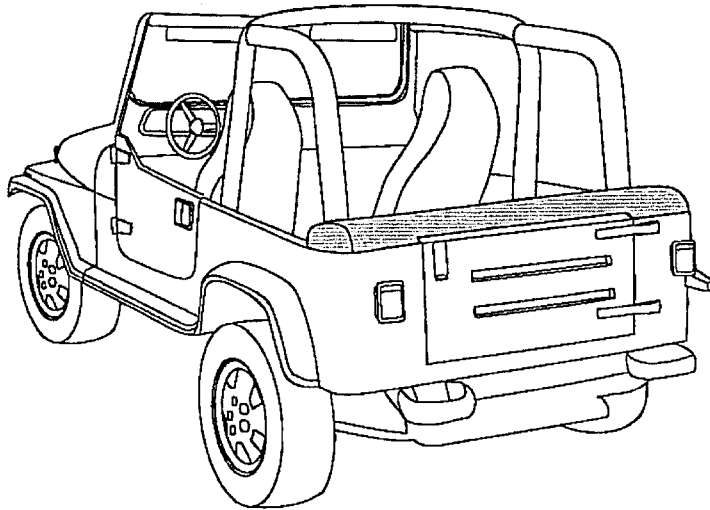

**GB**

**INSTALLATION INSTRUCTION**

Parts must not be fitted until registration of the vehicle has been obtained.

*JK Wrangler TOP BOOT*

**E**

**INSTRUCCIONES DE MONTAJE**

No se permite montar las piezas antes de registrar el vehículo.

**F**

**NOTICE DE MONTAGE**

Ne pas monter les pièces avant l'enregistrement du véhicule.

**JP**



Subject to alteration without notice  
Reservadas modificaciones técnicas  
Sous réserve de modifications techniques

822009912 65133  
822009911 65134

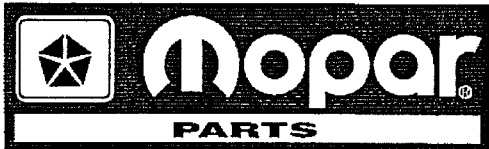
© DAIMLERCHRYSLER

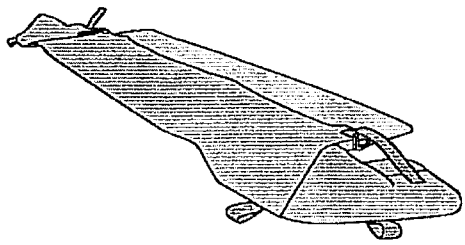

**GENUINE ACCESSORIES**

<p><b>Top Boot</b></p>  <p><b>A</b></p>	<p><b>Rear Window Bag</b></p>  <p><b>B</b></p>	<p><b>Quarter Window Bag</b></p>  <p><b>C</b></p>
--	---	--

**GENUINE ACCESSORIES**

**X2**

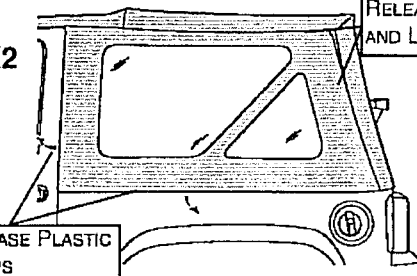

RELEASE HOOK AND LOOP STRIPS

RELEASE PLASTIC STRIPS

**X2**

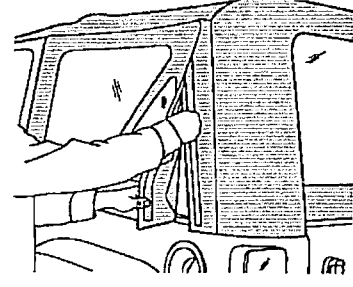

OPEN ZIPPER AND REMOVE QUARTER WINDOW

**1**

Release the hook and loop strips sewn along the top and rear of the Quarter Window.

Pull down and out on the plastic strip sewn along the bottom of the panel to release it from the retainer channel.

Open the zipper along the top and rear of the panel.

Remove the Quarter Window.

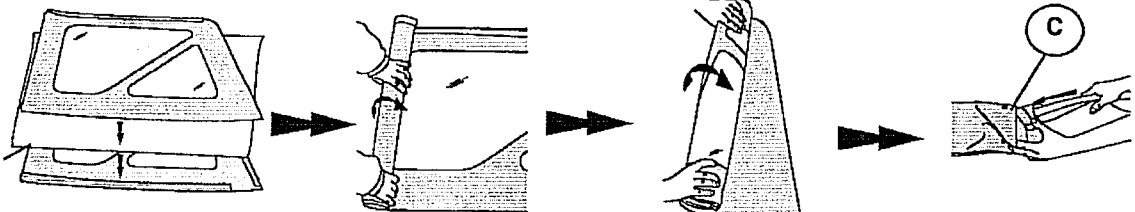

PAPER

**2**

LAY QUARTER WINDOWS ON TOP OF EACH OTHER

FOLD OVER CORNER TO FORM STRAIGHT EDGE

ROLL TIGHTLY, HOLDING PLASTIC AT BOTTOM

SLIDE INTO QUARTER WINDOW BAG.

Lay one Quarter Window on top of the other with paper in between to protect the glass.

Start at the rear of the windows and fold over the lower corner to form a straight edge. Roll the windows as tight as possible. Hold the plastic at the bottom of the rolled windows tightly and slide the windows into the Quarter Window Bag.

65035/65135

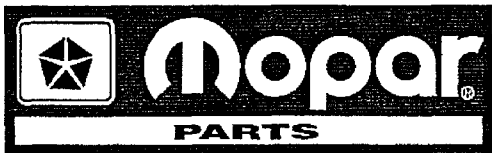

**GENUINE ACCESSORIES**

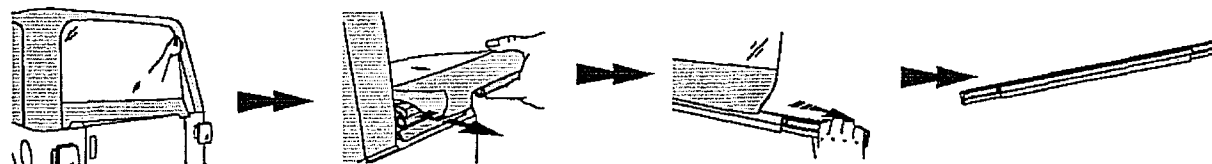

**3**

Open zipper on Rear Window. Pull the Tailgate Retainer Bar out of the mounts on the vehicle.

Slide the Tailgate Retainer Bar off the Rear Window and set it aside to be used later.

ROLL REAR WINDOW

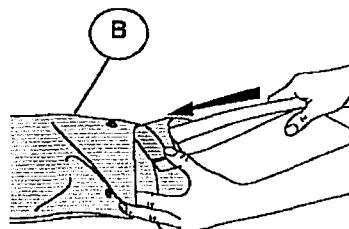
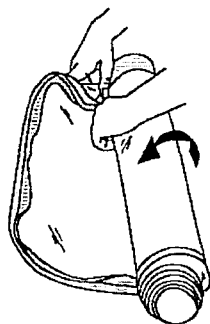

SLIDE INTO REAR WINDOW BAG

**4**

Start on the left side of the Rear Window and roll the window as tightly as possible. When you reach the

other side, fold over the corner and finish rolling. Slide the window into the Rear Window Bag.

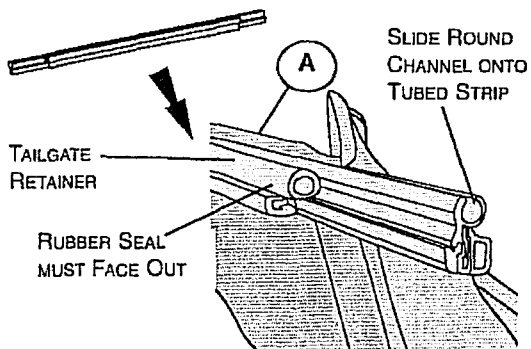

**5**

Slide the channel in the Tailgate Retainer from the top onto the tubed strip on the rear edge of the Top Boot. Make sure that the rubber seal on the Tailgate Retainer is facing out.

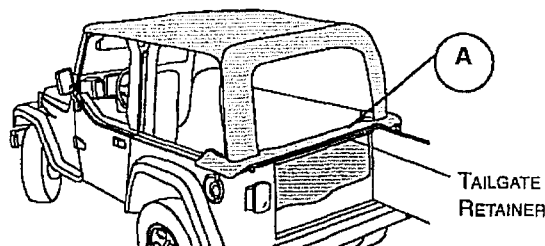

**6**

Orient the Top Boot with the Tubed Strip toward the rear.

65035/65135

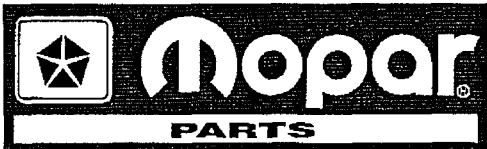

**GENUINE ACCESSORIES**

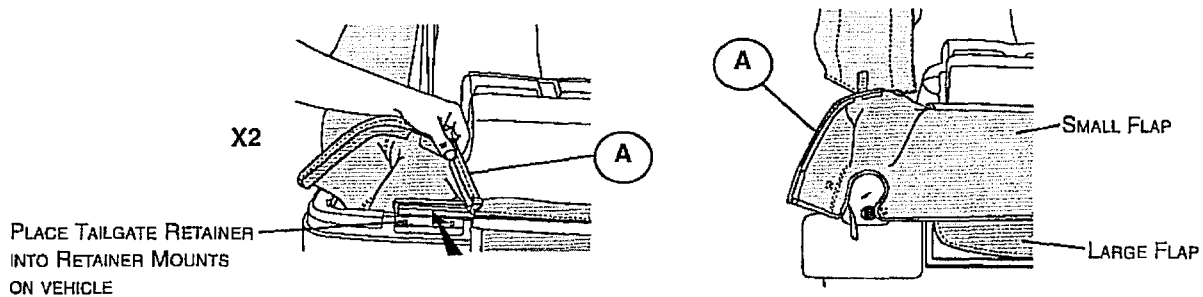

PLACE TAILGATE RETAINER INTO RETAINER MOUNTS ON VEHICLE

**7**

Insert the Tailgate Retainer into the Tailgate Clips on each side of the tailgate opening. The large flap on the Top Boot will lay inside the vehicle and the small flap will be outside the vehicle.

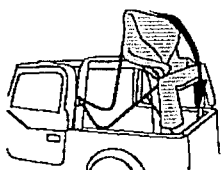

COLLAPSE BOWS AND FOLD TOWARD REAR



PULL SIDES OF TOP TOWARD CENTER AND PUSH FABRIC INTO THE REAR OF THE VEHICLE

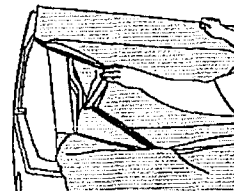

PULL FABRIC TOWARD THE CENTER

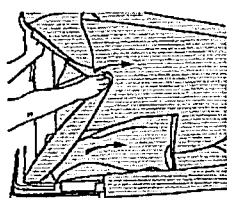

FOLD THE REAR LEGS OF THE TOP INTO THE CENTER

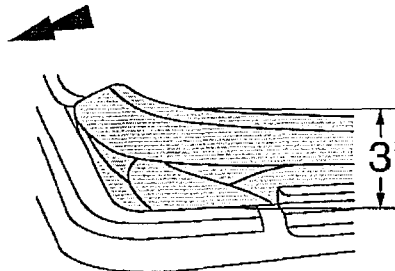

WITH THE FABRIC FOLDED TIGHTLY UNDER THE BOWS AND INSIDE THE VEHICLE, THE TOP OF THE HEADER SHOULD BE 3" ABOVE THE EDGE OF THE VEHICLE WHEN THE BOWS ARE COLLAPSED

**8**

Release the front of the top from the windshield. Raise the front of the deck and collapse the rear bows. From the rear, pull the sides of the fabric in toward the center

and push the fabric into the tub of the vehicle. Pull the fabric behind the rear bow tightly around the corners of the bow and fold the rear legs of the top toward the center.

Once the fabric is inside of the vehicle, lay the bows and the header down on the rear of the vehicle. The top of the header should be 3" above the edge of the vehicle.

65035/65135

**GENUINE ACCESSORIES**

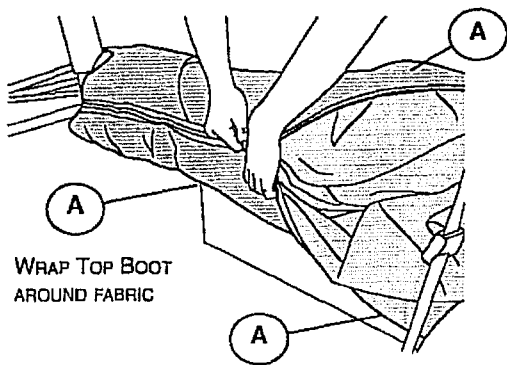

**WRAP TOP BOOT AROUND FABRIC**

**9** Wrap the Top Boot around the top fabric. Tuck everything in. Use one hand to pull the two flaps together to assist in closing the zipper.

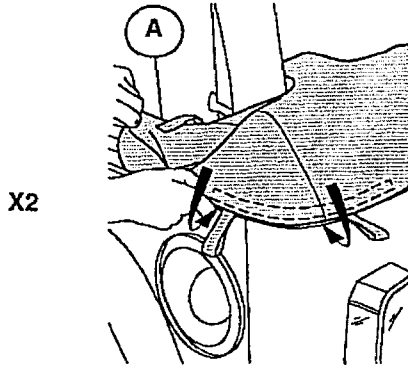

X2

**10** Locate the plastic strips sewn into the corners of the Top Boot. Roll the plastic strips into the retainers on the vehicle.

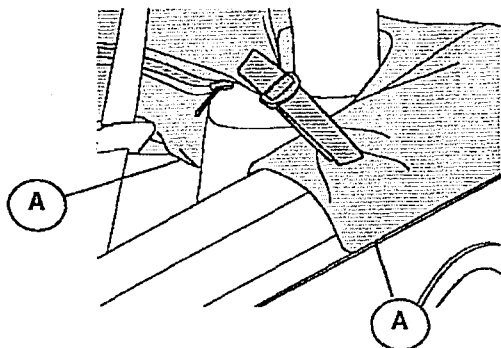

**11** Thread the strap sewn to the side of the Top Boot through the buckle sewn to the rear part of the cover. Pull the strap tight around the Sport Bar.

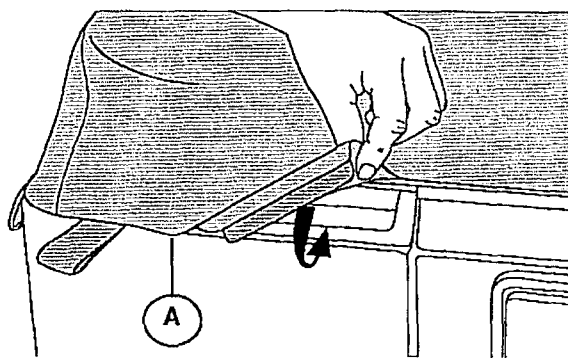

**12** Locate the Plastic Strip sewn to the Top Boot next to the tailgate opening on each side of the vehicle. Slip it into the retainer on the vehicle.

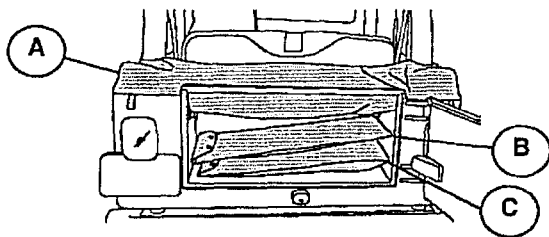

**13** Place the two window bags behind the rear seat just inside the tailgate.