



Mopar

PARTS

JEEP WRANGLER

DAIMLERCHRYSLER

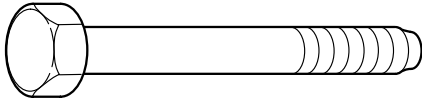

A 2x

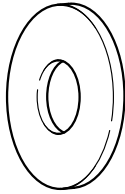

B 2x

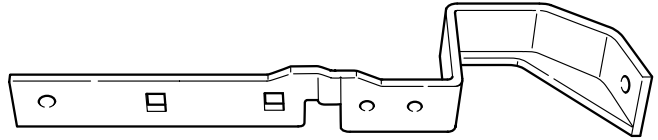

C

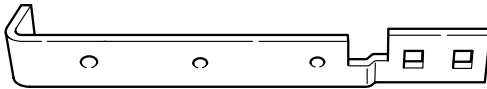

D

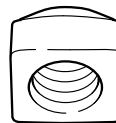

E 4x

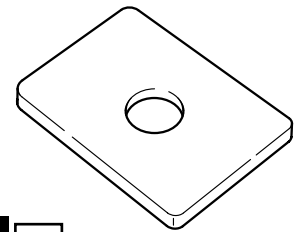

F 2x

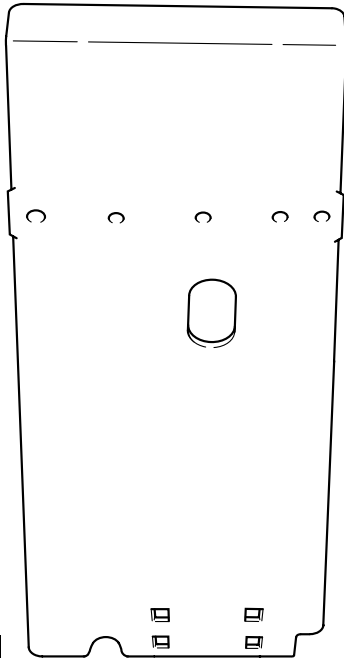

G

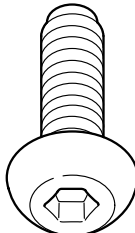

H 4x

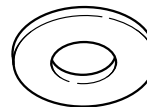

I 2x



J 4x

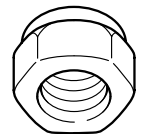

K 2x

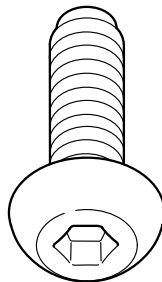

L

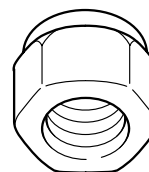

M

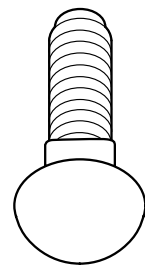

N 2x

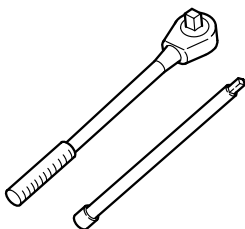

1/2"
13mm
21mm
22mm

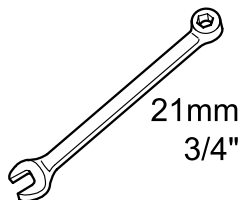

21mm
3/4"

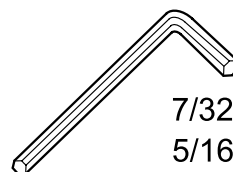

7/32"
5/16"

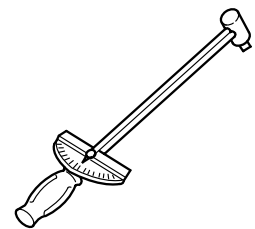

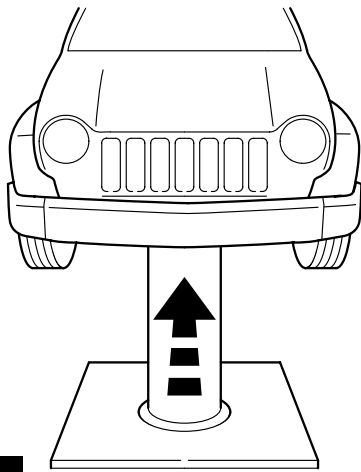

1

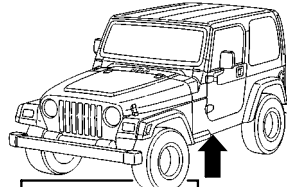

2003

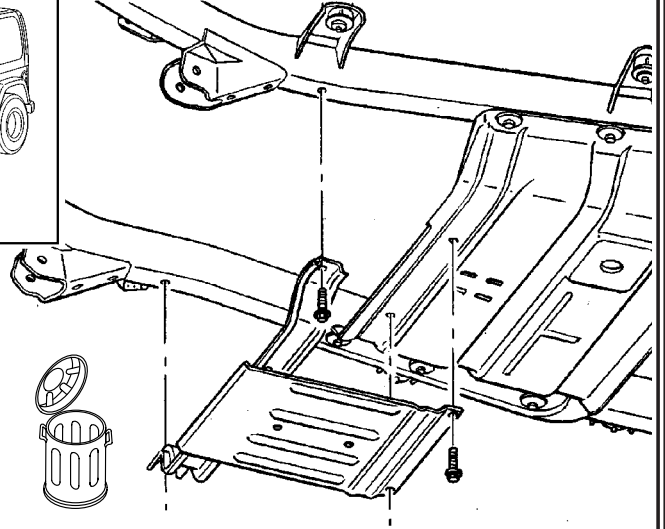

2



WARNING

Do not remove both M14 trailing arm bolts at the same time. If you do, the front axle may shift causing the vehicle or axle to be unstable. For this reason remove and install the trailing arm bolts one at a time.



Advertencia

No remueva los dos pernos M14 del brazo portante al mismo tiempo. Si lo hace, el eje delantero podría desplazarse, haciendo que el vehículo o el eje queden inestables. Por este motivo, se debe remover e instalar los pernos del brazo portante uno a la vez.



Avertissement !

Ne pas retirer les deux boulons M14 du bras longitudinal en même temps, car cela pourrait causer un déplacement de l'axe et rendre celui-ci ou le véhicule instable. C'est pour cette raison que les boulons de bras longitudinal doivent être retirés l'un après l'autre.

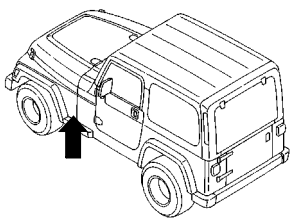

3

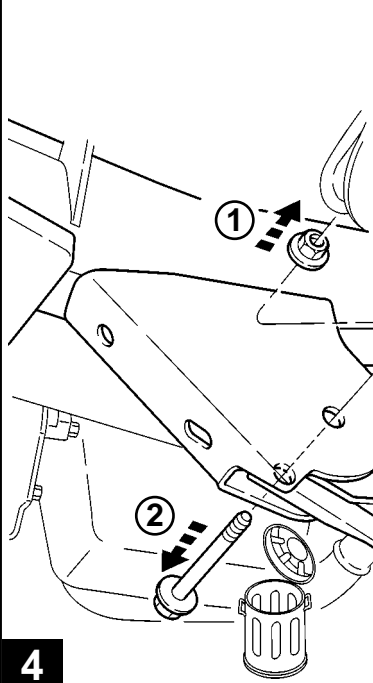
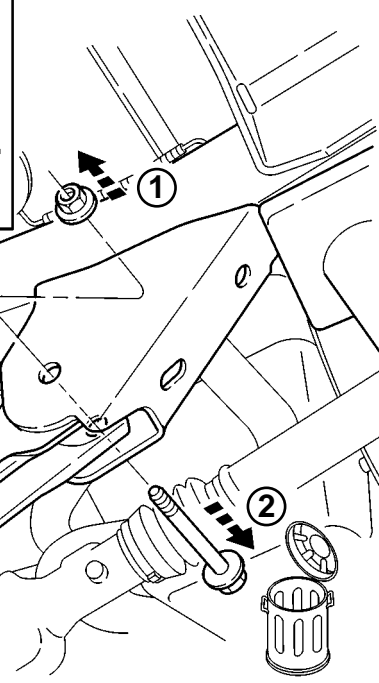

4

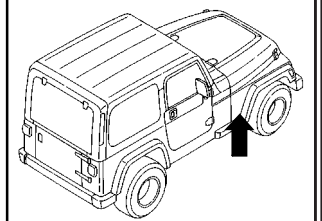

PASSENGER'S SIDE
LADO DEL PASAJERO
CÔTÉ PASSAGER

DRIVER'S SIDE
LADO DEL CONDUCTOR
CÔTÉ CONDUCTEUR

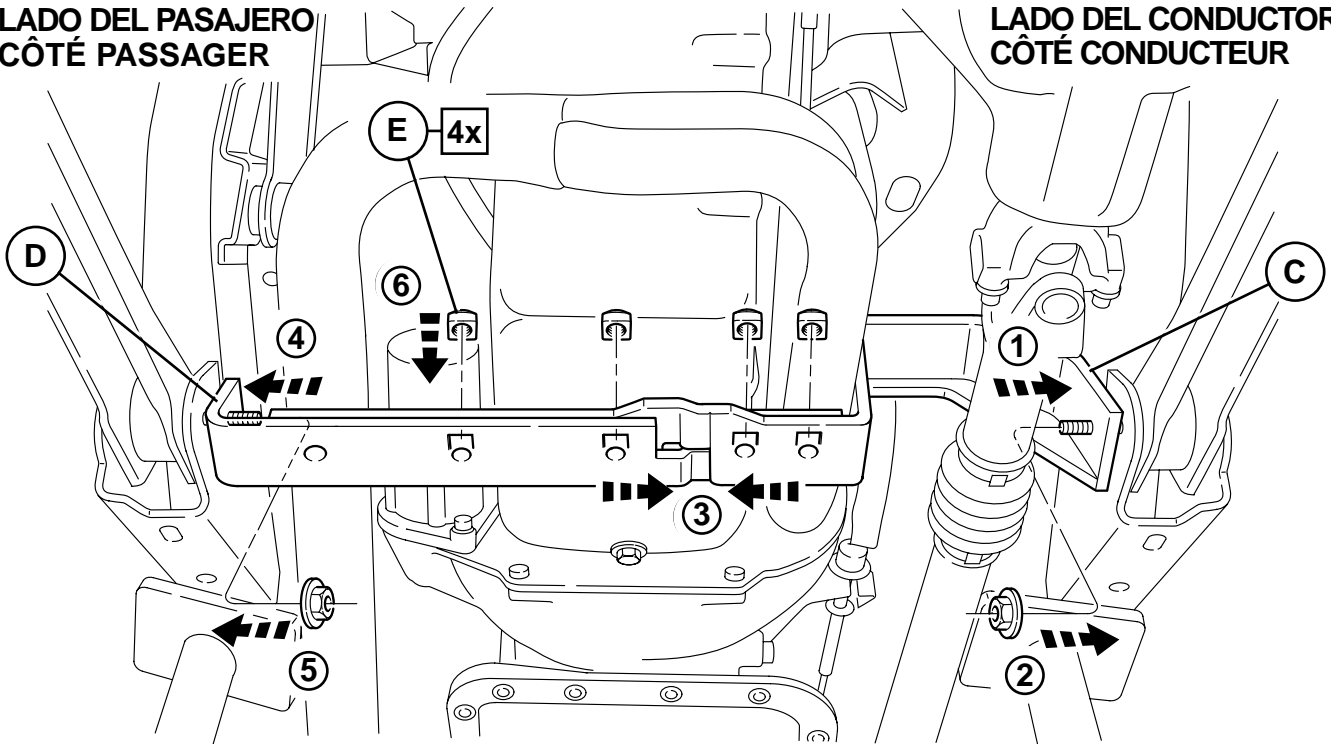

Tighten the driver's side down. If there is a gap on the passengers's side between the bracket and frame, use one or both of the supplied shims (Item F) to take up the space.

Apriete el lado del conductor. Si del lado del pasajero queda una separación entre el soporte y el bastidor, utilice uno de los suplementos incluidos o ambos (Elemento F) para eliminarla.

Serrer le boulon du côté passager. S'il y a un espace entre le support et le châssis, utiliser l'une des cales fournies (article), ou les deux, pour combler cet espace.

5

